

Butterfly Valve c/w Signal Gearbox - Wafer End

Technical Features

Flange Standard: ANSI 125/150, DIN2501 PN10/16

Connection: Wafer End

Sizes: 2" , 2 1/2" , 3" , 4" , 5" , 6" , 8" , 10" , 12"

Working Pressure: 300 PSI (Maximum Testing Pressure 600 PSI)
conforms to UL 1091

Working Temperature Range: 0C°-80C°(32°F-176°F)

Application: Indoor & Outdoor Use, Fire inflow water, drain pipe, high-rising building fire fighting system, industrial factory building fire protection system

Coating Details: Epoxy coated interior and exterior by Electrostatic Spray or coating upon request

Disc: Ductile Iron EPDM Rubber Encapsulated

Top Flange Standard: ISO 5211

Certified lead-free by: NSF / ANSI 61 & NSF / ANSI 372 is available

Approval: UL

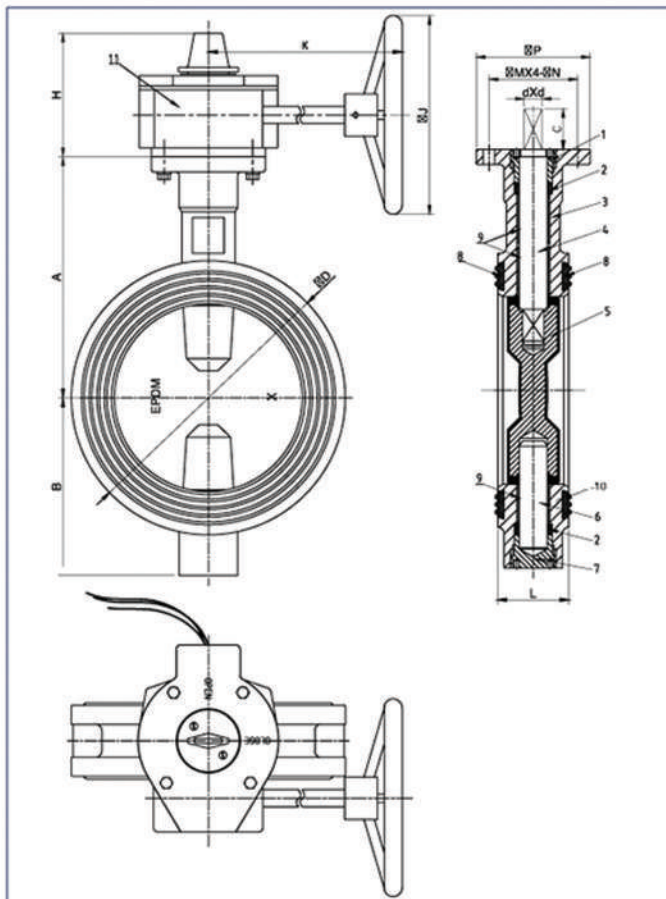

Valve Material List

NO	Description	Material	Standard
1	Upper Shaft Sealing Nut	WCB	ASTM A216
2	Shaft Seal	EPDM	ASTM D2000
3	Body	Ductile Iron	ASTM A536 Grade 65-45-12
4	Upper Shaft	416 Stainless steel	ASTM A582
5	Disc + Rubber Seat	Ductile Iron + EPDM	ASTM A536 + ASTM D2000
6	Lower Shaft	416 Stainless steel	ASTM A582
7	Lower Shaft Sealing Nut	WCB	ASTM A216
8	End Face Seal	EPDM	ASTM D2000
9	Stem BuShing	PTFE/C95400	
10	O-Ring	EPDM	ASTM D2000
11	Gearbox		

Dimensions

Size	A	B	C	D	H	K	J	P	M	N	d	L	
2"	110	85	32	100	111	153	218	152	90	70	9	10	42
2 1/2"	125	95	32	112	111	153	218	152	90	70	9	10	44.2
3"	140	100	32	120	111	153	218	152	90	70	9	11	45.3
4"	160	100	32	161	111	153	218	152	90	70	9	14	52
5"	170	125	32	182	111	153	218	152	90	70	9	14	54.4
6"	190	140	32	216	111	153	218	200	90	70	9	16	55.8
8"	230	175	32	260	1256	210	232	300	125	102	12	19	60.5
10"	260	200	320	320	126	210	232	300	125	102	12	24	66.5
12"	300	240	375	375	161	249	350	150	125	14	26	76.9	